



DR3 Server Installation Guide

Document Version 0.1

Sep 2018

© Copyright Bitmaintech Pte.Ltd. 2007 – 2018. All rights reserved.

Bitmaintech Pte.Ltd. (Bitmain) reserves the right to make corrections, modifications, enhancements, improvements, and other changes to its products and services at any time and to discontinue any product or service without notice.

Customers should obtain the latest relevant information before placing orders and should verify that such information is current and complete. All products are sold subject to Bitmain's terms and conditions of sale supplied at the time of order acknowledgment.

Bitmain warrants performance of its products to the specifications applicable at the time of sale in accordance with Bitmain's standard warranty. Testing and other quality control techniques are used to the extent Bitmain deems necessary to support this warranty. Except where mandated by government requirements, testing of all parameters of each product is not necessarily performed.

Bitmain assumes no liability for third-party applications assistance. Customers are responsible for their products and applications using Bitmain components. To minimize the risks associated with customer products and applications, customers should provide adequate design and operating safeguards.

Bitmain does not warrant or represent that any license, either express or implied, is granted under any Bitmain patent right, copyright or other Bitmain intellectual property right relating to any combination, machine, or process in which Bitmain products or services are used. Information published by Bitmain regarding third-party products or services does not constitute a license from Bitmain to use such products or services or a warranty or endorsement thereof. Use of such information may require a license from a third party under the patents or other intellectual property of the third party, or a license from Bitmain under the patents or other intellectual property of Bitmain.

Resale of Bitmain products or services with statements different from or beyond the parameters stated by Bitmain for that product or service voids all express and any implied warranties for the associated Bitmain product or service and is an unfair and deceptive business practice. Bitmain is not responsible or liable for any such statements.

All company and brand products and service names are trademarks or registered trademarks of their respective holders.

All text and figures included in this publication are the exclusive property of Bitmaintech Pte.Ltd. (Bitmain), and may not be copied, reproduced, or used in any way without the express written permission of Bitmain. Information in this document is subject to change without notice and does not represent a commitment on the part of Bitmain. Although the information in this document has been carefully reviewed, Bitmain does not warrant it to be free of errors or omissions. Bitmain reserves the right to make corrections, updates, revisions or changes to the information in this document.

Bitmaintech Pte.Ltd.

Tel: +86-400-890-8855

www.bitmain.com

Table of Contents

1. Overview	4
1.1 DR3 Server Components	5
1.2 Specifications	6
2. Connecting the Power Supply	8
3. Setting Up the Server	9
4. Configuring the Server	11
5. Monitoring Your Server	12
6. Administering Your Server	13
6.1 Checking Your Firmware Version	13
6.2 Upgrading Your System	13
6.3 Modifying Your Pass Word	14
6.4 Restoring initial Settings	14

1. Overview

The DR3 server is Bitmain's newest version in the DR3 server series. All DR3 servers are tested and configured prior to shipping to ensure easy set up.



You must provide your own ATX power supply.

1.1 DR3 Server Components

The DR3 server main components and controller front panel are shown in the following figure:

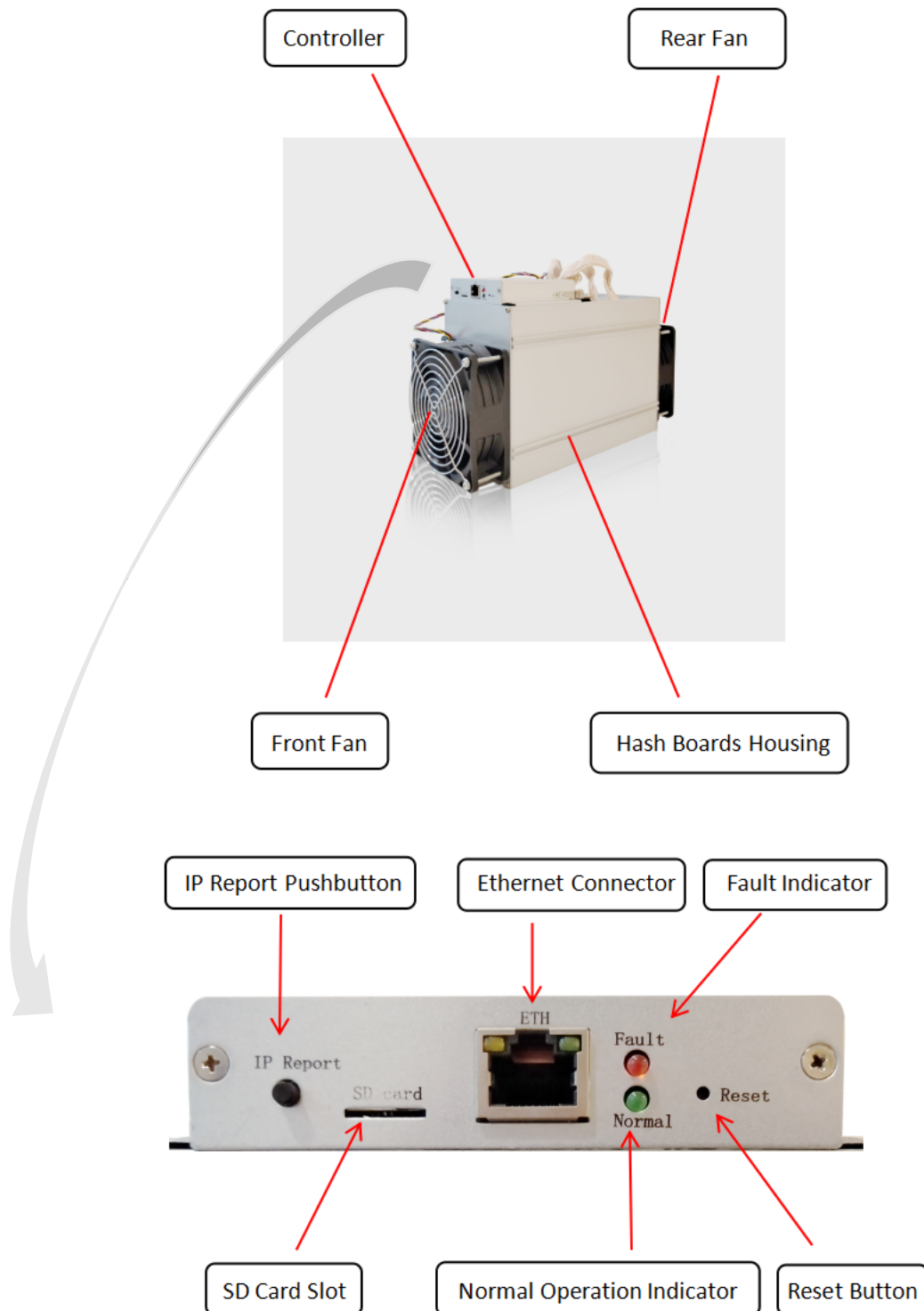

1.2 Specifications

Product Glance	Value
Product model	DR3
Hashrate, TH/s	7.80
Reference power on wall, Watt	1410
Reference power efficiency on wall @25°C, J/TH	180.73
Adapted AC/DC output requirement, Watt/ Volt	1605/ 12.00

Detailed Characteristics	Value		
	Min	Typ	Max
Hashrate & Power			
Hashrate, TH/s		7.80	8.00
Power efficiency on wall @25°C, J/TH⁽¹⁻¹⁾	180.73		188.11
Power efficiency on wall @40°C, J/TH⁽¹⁻²⁾	186.51		194.13
Reference power on wall, Watt⁽¹⁻³⁾	1410		1553
DC input voltage range, Volt⁽¹⁻⁴⁾	11.60	12.00	13.00
DC input current range, Amp⁽¹⁻⁵⁾		117.5	133.9
Adapted AC/DC output power requirement, Watt⁽¹⁻⁶⁾	1444	1605	
Hardware Configuration			
Quantity of hash chips	162		
Quantity of hash boards	3		
Networking connection mode	RJ45 ethernet 10/100M		
Server Size (Length*Width*Height, w/o package), mm	293*130*187		
Net weight, kg	3.83		
Noise, dBA @25°C⁽²⁻¹⁾			76
Environment Requirements			
Operation temperature,°C	0	25	40
Storage temperature,°C	-40	25	85
Operation humidity, RH	5%		95%

Notes:

(1-1) Refers PSU power conversion efficiency of 93%

(1-2) Refers PSU power conversion efficiency of 93%

(1-3) Min condition: 25°C, min J/TH, typical hashrate

Max condition: 40°C, max J/TH, max hashrate

Refers PSU power conversion efficiency of 93%

(1-4) **Caution: Wrong input voltage may probably cause server damaged**

(1-5) Typ condition: min reference power, typical DC input voltage

Max condition: max reference power, min DC input voltage

(1-6) Min condition: 40°C, max J/TH, max hashrate,

PSU output power should be no less than the min value to make sure mining stable.

Typical condition: (typical power) = (min power)/90%, leave power output margin for PSU.

Caution: It is strongly recommended that using typical power can make sure your server can work well. You can use one PSU to power multiple boards. Do not attempt to power one board with more than one PSU. All PCI-E ports are required to plug in while powering up the board.

(2-1) Max condition: Fan is under max RPM(rotation per minute).

**Note:**

Parameters above are the measured data of DR3 server in the laboratory environment, which is for reference only, the actual data may differ.

2. Connecting the Power Supply

Ten PCI-e connectors are located at the top of the DR3 server for connecting the PSU as follows:

- Nine PCI-e connectors for the hash boards. Each hash board has three PCI-e connectors.
- One PCI-e connector located on the controller.



Each hashboard must be powered by the same PSU to prevent possible damage and instability.

To connect the power supply:

1. Connect PSU power cable connectors to each of the three PCI-e connectors on the top of the DR3 server, ensuring that each hash board is powered by the same PSU.

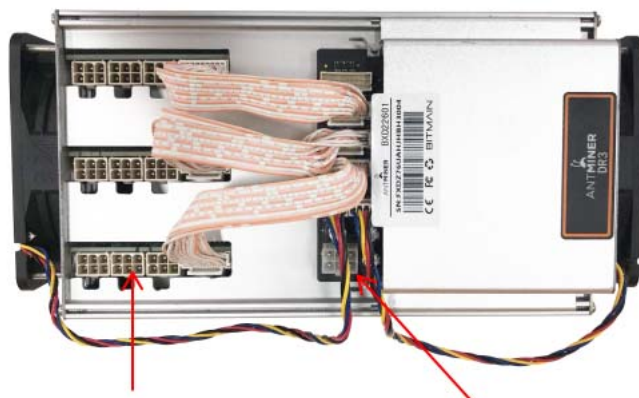

Hash Boards PCI-e Power Connector

Controller PCI-e Power Connector

2. Connect a PSU power cable connector to the DR3 PCI-e connector on the controller.
3. Connect the network cable to the ETH port.
4. To power up your DR3 server, connect the PSUs to the power wall outlet.



If you are using more than one PSU, power up the PSU connected to the controller AFTER you have Powered up the other PSU(s).

3. Setting Up the Server

To set up the server:

 The file IPReporter.zip is supported by Microsoft Windows only.

1. Go to the following site:
<https://shop.bitmain.com/support.htm?pid=00720160906053730999PVD2K0vz0693>
2. Download the following file: IPReporter.zip
3. Extract the file.

 The default DHCP network protocol distributes IP addresses automatically.

4. Right-click **IPReporter.exe** and run it as Administrator.
5. Select one of the following options:
 - Shelf, Step, Position – suitable for farm servers to mark the location of the servers.
 - Default – suitable for home servers.
6. Click **Start**.

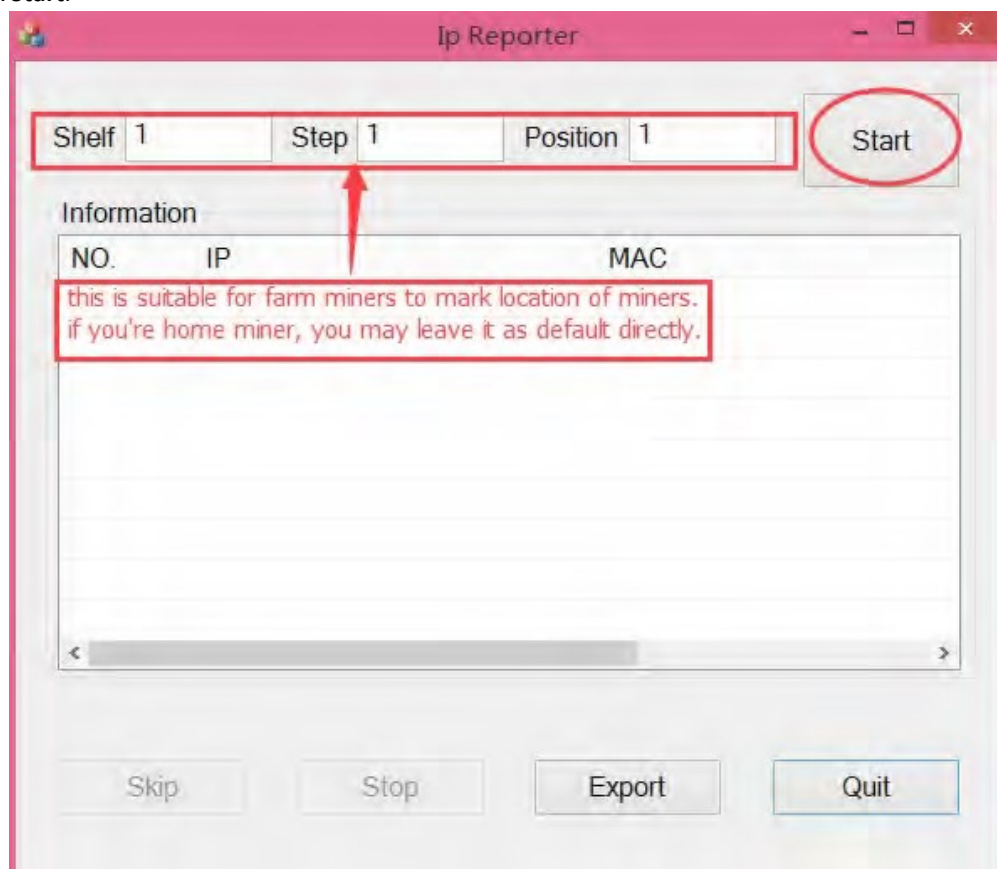

3. Setting Up the server

- On the controller board, click the IP Report button. Hold it down until it beeps (about 5 seconds).

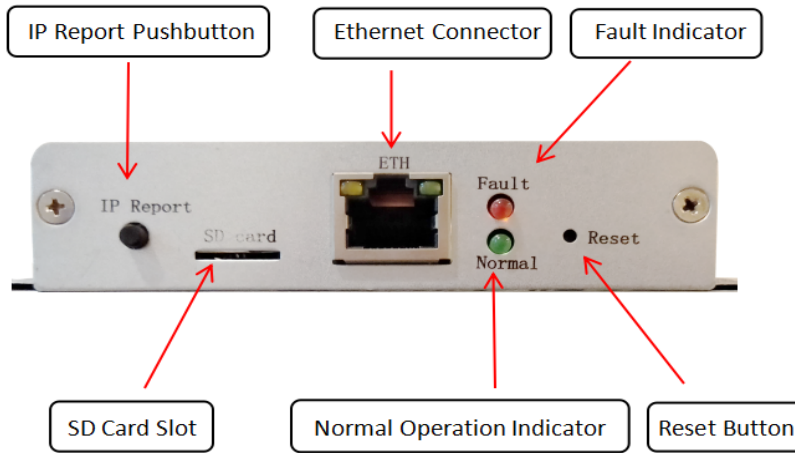

The IP address will be displayed in a window on your computer screen.

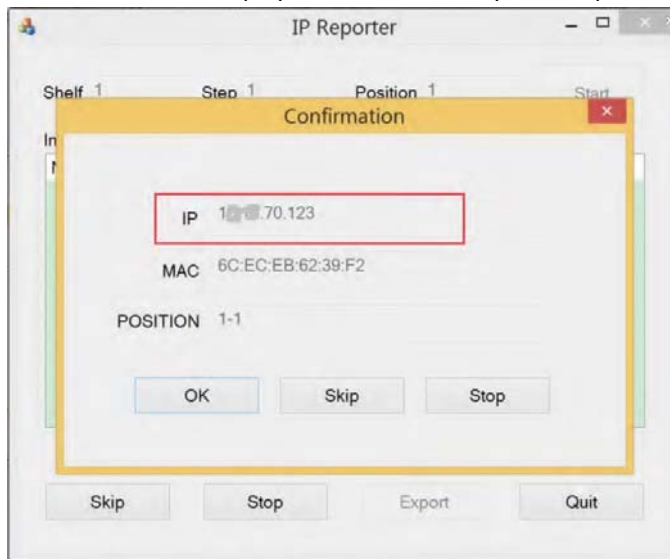

- In your web browser, enter the IP address provided.
- Proceed to login using `root` for both the username and password.
- In the Network section, you can assign a DHCP IP address (optional).
- Click **Save & Apply**.

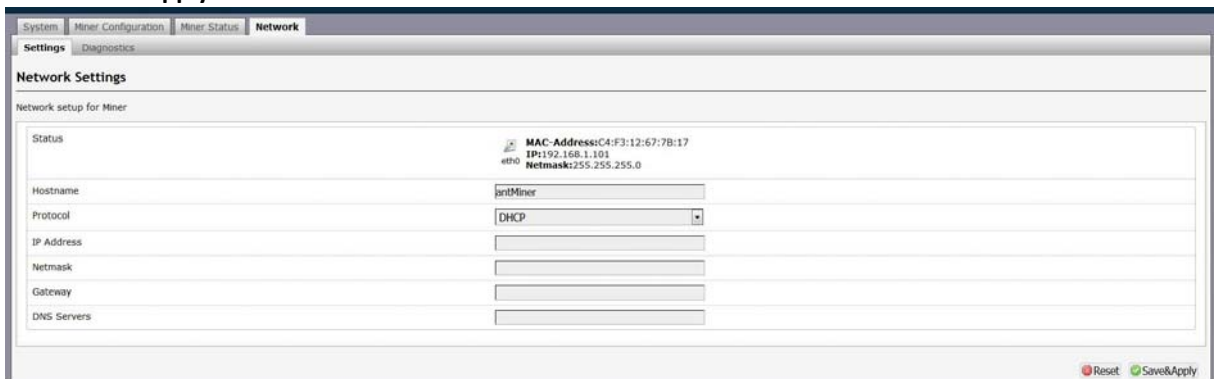



4. Configuring the Server

Setting Up the Pool

To configure the server:

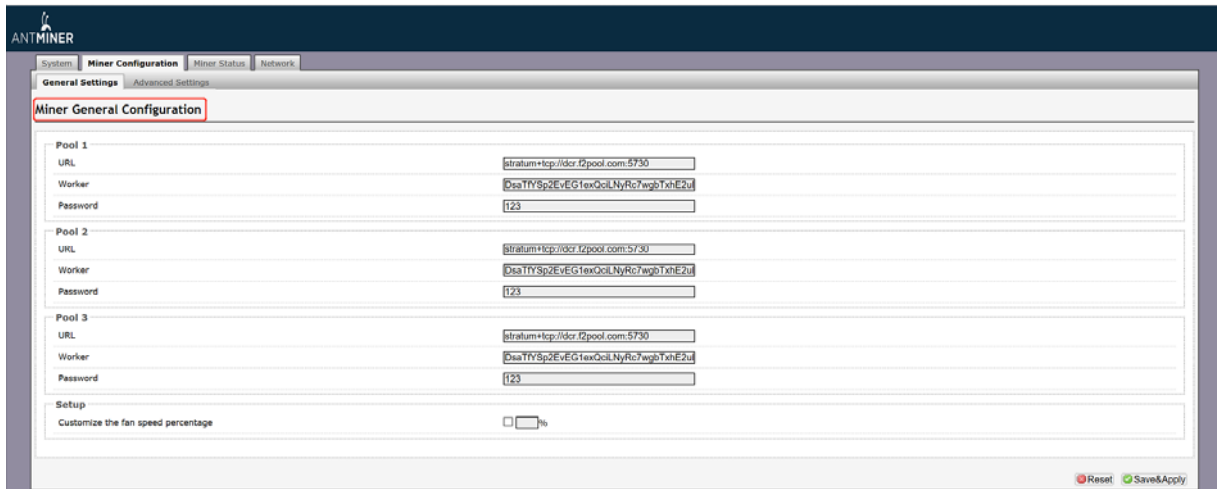
1. click **General Settings**.



 **Note:** Fan speed can be adjusted, but we recommend keeping the default setting.

2. Set the options according to the following table:

Option	Description
Pool URL	Enter the URL of your desired pool. <div style="border: 1px solid black; padding: 10px; margin-top: 10px;">  <p>The DR3 server can be set up with three mining pools, with decreasing priority from the first pool (pool 1) to the third pool (pool 3). The pools with low priority will only be used if all higher priority pools are offline.</p> </div>
Worker	Your worker ID on the selected pool.
Password	The password for your selected worker.

3. Click **Save & Apply** to save and restart the server.

5. Monitoring Your server

To check the operating status of your server:

1. Click the status marked below.

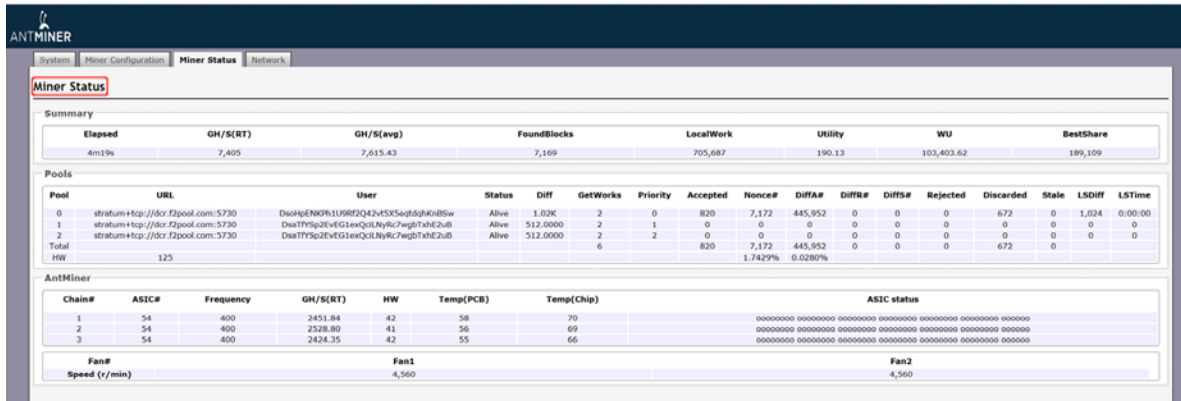

2. monitor your server according to the descriptions in the following table:

Option	Description
ASIC#	Number of chips detected in the chain.
Frequency	ASIC frequency setting.
GH/S(RT)	Hash rate of each hash board (GH/s)
Temp(PCB)	Temperature of each hash board (°C).(Applied only to server with fixed frequency)
Temp(Chip)	Temperature of the chips on each hash board (°C).
ASIC status	One of the following statuses will appear: <ul style="list-style-type: none"> ● O - indicates OK ● X - indicates error ● - - indicates dead



Note: The DR3 server is with fixed frequency 400 MHz. Firmware will stop running when the Temp(PCB) reaches to 85°C , there will be an error message "Fatal Error: Temperature is too high!" shown in the bottom of kernel log page.

6. Administering Your Server

6.1 Checking Your Firmware Version

To check your firmware version:

1. In **System**, click the **Overview** tab.
2. **File System Version** displays the date of the firmware your server use. In the example below, the server is using firmware version 20180906.

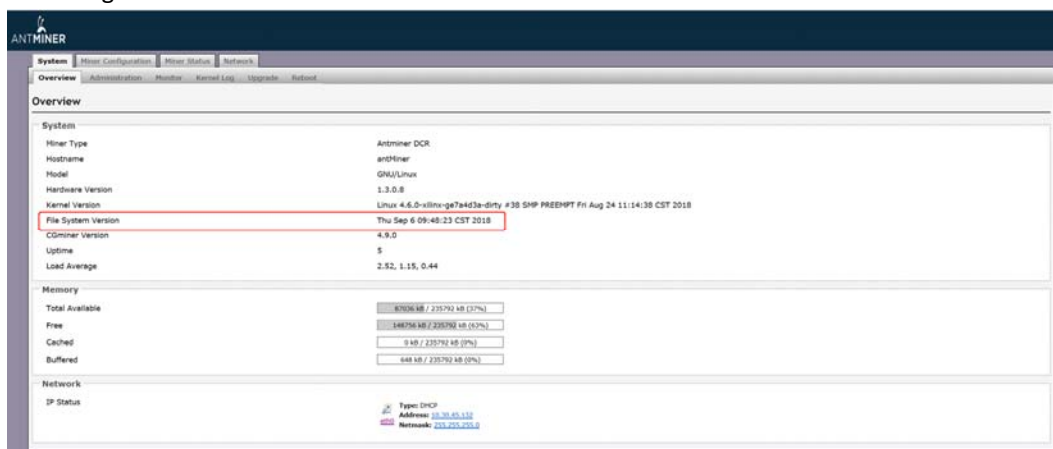

6.2 Upgrading Your System



Make sure that the DR3 server remains powered during the upgrade process. If power fails before the upgrade is completed, you will need to return it to Bitmain for repair.

To upgrade the server's firmware:

1. In System, click **Upgrade**.

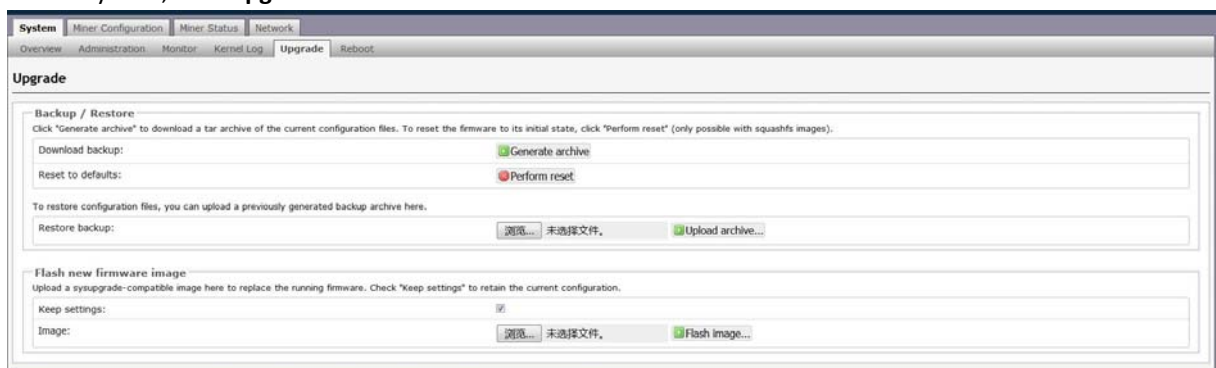

2. For **Keep Settings**:
 - Select the check box to keep your current settings (default).
 - Clear the check box to reset the server to default settings.
3. Click the 选择文件 (**Browse**) button and navigate to the upgrade file. Select the upgrade file, then click **Flash image**. A message appears notifying you if the DR3 firmware can be upgraded and if yes, will then proceed to flash the image.
4. When the upgrade is completed, the following message appears:

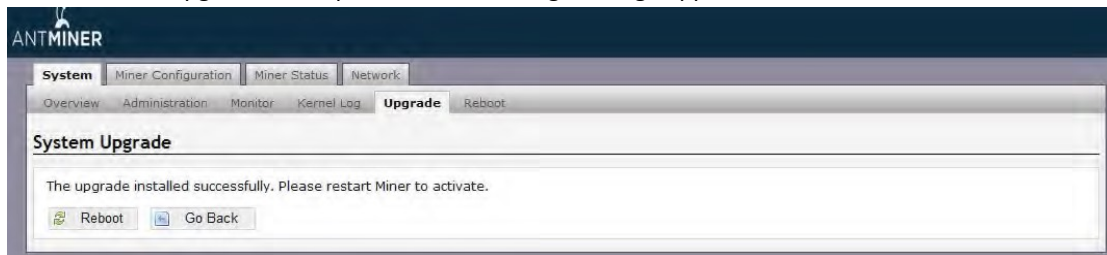

5. Click one of the following options:
 - **Reboot** - to restart the server with the new firmware.
 - **Go Back** - to continue mining with the current firmware. The server will load the new firmware next time it is restarted.

6.3 Modifying Your Password

To change your login password:

1. In **System**, click the **Administration** tab.
2. Set your new password, then click **Save & Apply**.

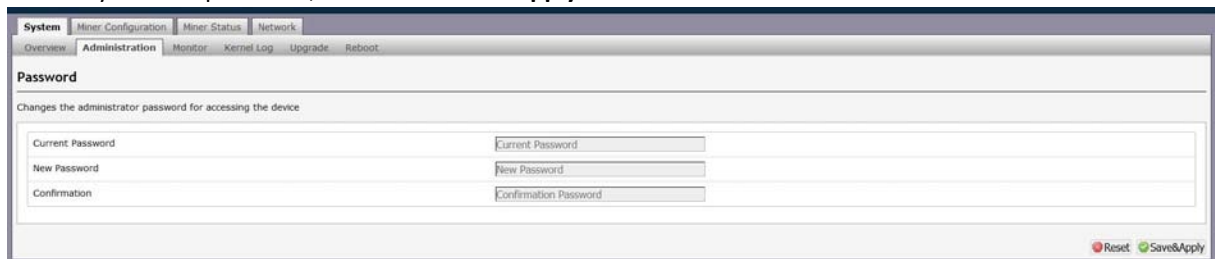

6.4 Restoring Initial Settings

To restore your initial settings

1. Turn on the server and let it run for 5 minutes.
2. On the controller front panel, press and hold the **Reset** button for 10 seconds.



Resetting your server will reboot it and restore its default settings. The red LED will automatically flash once every 15 seconds if the reset is operated successfully.

Regulation:

FCC Notice (FOR FCC CERTIFIED MODELS) :

This device complies with part 15 of the FCC Rules. Operation is subject to the following two conditions: (1) This device may not cause harmful interference, and (2) this device must accept any interference received, including interference that may cause undesired operation.

Note:

This equipment has been tested and found to comply with the limits for a Class A digital device, pursuant to part 15 of the FCC Rules. These limits are designed to provide reasonable protection against harmful interference when the equipment is operated in a commercial environment. This equipment generates, uses, and can radiate radio frequency energy and, if not installed and used in accordance with the instruction manual, may cause harmful interference to radio communications. Operation of this equipment in a residential area is likely to cause harmful interference in which case the user will be required to correct the interference at his own expense.

EU WEEE: Disposal of Waste Equipment by Users in Private Household in the European Union



This symbol on the product or on its packaging indicates that this product must not be disposed of with your other household waste. Instead, it is your responsibility to dispose of your waste equipment by handing it over to a designated collection point for the recycling of waste electrical and electronic equipment. The separate collection and recycling of your waste equipment at the time of disposal will help to conserve natural resources and ensure that it is recycled in a manner that protects human health and the environment. For more information

about where you can drop off your waste equipment for recycling, please contact your local city office, your household waste disposal service or the shop where you purchased the product.

台灣 ROHS:

設備名稱： ， 型號：

單元	有害物質					
	鉛 (Pb)	汞 (Hg)	鎘 (Cd)	六價鉻 (Cr+6)	多溴聯苯 (PBB)	多溴二苯醚 (PBDE)
外殼	○	○	○	○	○	○
電路板組件	—	○	○	○	○	○
其他線材	—	○	○	○	○	○

備考 1. “超出 0.1 wt %” 及 “超出 0.01 wt %” 係指限用物質之百分比含量超出百分比含量基準

值。

備考 2. “○” 係指該項限用物質之百分比含量未超出百分比含量基準值。

備考 3. “—” 係指該項限用物質為排除項目